

ORDERING DATA: MODEL JC1 SWITCHES

TO ORDER SPECIFY:

Product, Series, Design No., Type, Positions, Output Type, and Cable Options.

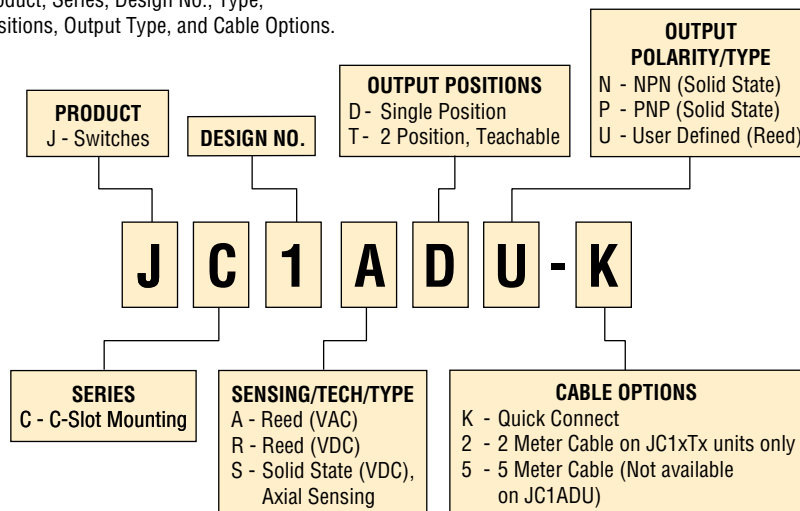

JC1 SOLID STATE AND REED CORDSETS

PART NO.	DESCRIPTION
63549-02	M8, 3 pin, Straight Female Connector, 2 meter cable
63549-05	M8, 3 pin, Straight Female Connector, 5 meter cable
81284-1-010	M12, 3 pin, Straight Female Connector, 2 meter cable

Cordsets are ordered separately.

JC1ST TEACHABLE CORDSET

PART NO.	DESCRIPTION
81284-1-001	M8, 4 pin, Straight Female Connector, 5 meter cable

Cordsets are ordered separately.

SWITCH CROSS REFERENCE CHART

CURRENT 6790 SWITCH	DESCRIPTION	JC1 SWITCH
67902-1-05	PNP or NPN DC Reed, 5 meter cable	JC1RDU-5
67903-1-02	NPN DC Solid State, 2 meter cable	JC1SDN-5
67903-1-05	NPN DC Solid State, 5 meter cable	JC1SDN-5
67904-1-02	PNP DC Solid State, 2 meter cable	JC1SDP-5
67904-1-05	PNP DC Solid State, 5 meter cable	JC1SDP-5
67922-1	PNP or NPN DC Reed, Quick Connect	JC1RDU-K
67923-1	NPN DC Solid State, Quick Connect	JC1SDN-K
67924-1	PNP DC Solid State, Quick Connect	JC1SDP-K
67929-2	AC Reed, Quick Connect	JC1ADU-K

BENEFITS: SERIES JC1 SWITCHES

Common Benefits for JC1 Switches

- Fits into 4 mm switch slot
- IP67 Environmental Protection
- LED indicator for convenient setting and troubleshooting
- Integrated protection circuitry including short circuit protection
- Polyurethane (PUR) jacketed cable
- Improved switch hysteresis and magnetic response uniformity
- Quick connect available



Solid State JC1SD

- Longest life and most reliable operation
- Integrated protection to eliminate multi-tripping
- Offered in 10-30 VDC current sinking (NPN) and current sourcing (PNP) versions for simple interfacing to system controllers.
- Available in cabled (5 meter) or quick connect versions.

Reed JC1AD and JC1RD

- Available in 4.5-30 VDC current sinking or sourcing or 65-120 VAC models for simple interfacing to sequencers and programmable controllers.
- Can be used to directly drive some types of relays or valve solenoids within the switch specifications stated.
- JC1RD is available in 5 meter cabled or quick connect.
- JC1AD is available in quick connect only.

Teachable JC1ST

- Teachable switches feature two easy-to-program outputs. See Programming Guide on page 7-28. Output settings are retained after power interruption.
- Since each switch provides two outputs, an actuator with only two slots may have up to four outputs by using two switches.
- Offered in 12-30 VDC current sourcing (PNP) version only
- Available in cabled (2 meter) or quick connect versions.

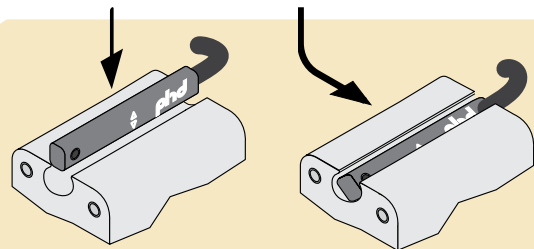

JC1 switches have a unique housing design which allows “drop-in” installation from the side, does not have to be inserted from the end of the slot.

Tilt switch to drop in, then rotate logo up.

ENGINEERING DATA: SERIES JC1SD SOLID STATE SWITCHES

PART NO.	DESCRIPTION
JC1SDP-5	PNP (Source), Solid State, 10-30 VDC, 5 meter cable
JC1SDP-K	PNP (Source), Solid State, 10-30 VDC, Quick Connect
JC1SDN-5	NPN (Sink), Solid State, 10-30 VDC, 5 meter cable
JC1SDN-K	NPN (Sink), Solid State, 10-30 VDC, Quick Connect

SPECIFICATIONS	JC1SDP-x	JC1SDN-x
OPERATING PRINCIPLE	Solid State Detection of Moving Magnet	
INPUT VOLTAGE	10-30 VDC	
OUTPUT TYPE	PNP (Source)	NPN (Sink)
OUTPUT CURRENT	100 mA max., Short Circuit Protection	
VOLTAGE DROP	≤ 2.5 VDC	
SWITCH BURDEN	≤ 8 mA	
ENVIRONMENTAL	IP67	
OPERATING TEMPERATURE	-30° to 80°C	

MATCHING CORDSET

PART NO.	DESCRIPTION
63549-02	M8, 3 pin, Straight Female Connector, 2 meter cable
63549-05	M8, 3 pin, Straight Female Connector, 5 meter cable

SOLID STATE WIRING SCHEMATICS

JC1SDN-5 CABLED MODEL - NPN (SINK)

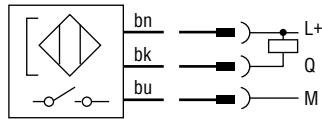

JC1SDP-5 CABLED MODEL - PNP (SOURCE)

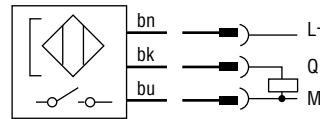

JC1SDN-K QUICK CONNECT MODEL - NPN (SINK)

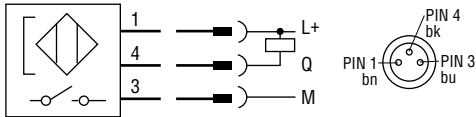

JC1SDP-K QUICK CONNECT MODEL - PNP (SOURCE)

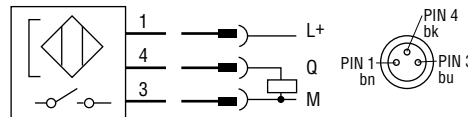

DIMENSIONS: SERIES JC1SD SOLID STATE SWITCHES

JC1SDx-5

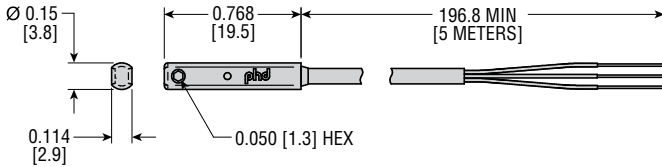

JC1SDx-K (Quick Connect)

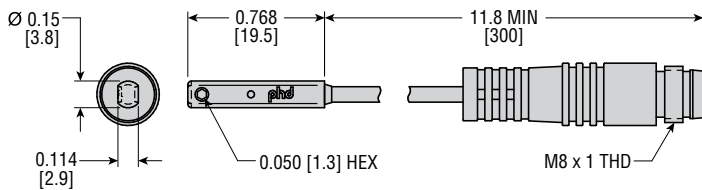

63549-xx CORDSET

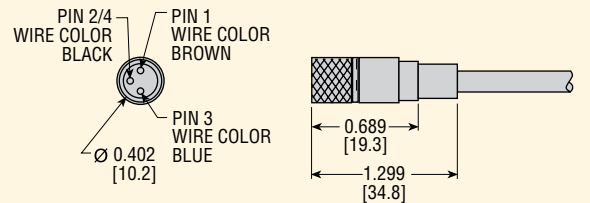

ENGINEERING DATA: SERIES JC1AD & JC1RD REED SWITCHES

PART NO.	DESCRIPTION
JC1RDU-5	PNP or NPN DC Reed, 5 meter cable
JC1RDU-K	PNP or NPN DC Reed, Quick Connect
JC1ADU-K	AC Reed, Quick Connect (M12)

PART NO.	DESCRIPTION
63549-02	M8, 3 pin, Straight Female Connector, 2 meter cable
63549-05	M8, 3 pin, Straight Female Connector, 5 meter cable
81284-1-010	M12, 3 pin, Straight Female Connector, 2 meter cable

Cordsets are ordered separately.

SPECIFICATIONS	JC1RDU	JC1ADU
OPERATING PRINCIPLE	Magnetic Reed	
ACTUATED BY	Piston Magnet	
INPUT VOLTAGE	4.5-30 VDC	65-120 VAC
OUTPUT TYPE	Contact Closure	
CURRENT RATING	75 mA max.	25 mA max.
IMPEDANCE	0.15 Ohm max.	1.5 kOhm
ENVIRONMENTAL	IP67	
OPERATING TEMPERATURE	-25° to 75°C	

REED WIRING SCHEMATICS

JC1RDU-5

CABLED MODEL - NPN (SINK)

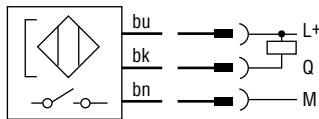

CABLED MODEL - PNP (SOURCE)

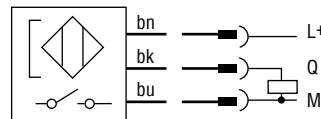

JC1RDU-K

QUICK CONNECT MODEL - NPN (SINK)

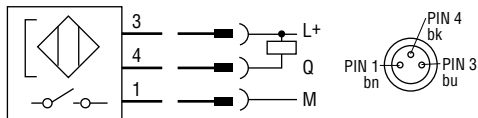

QUICK CONNECT MODEL - PNP (SOURCE)

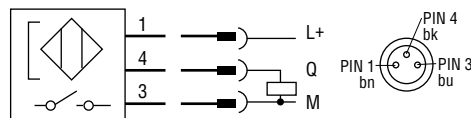

AC REED WIRING SCHEMATICS

JC1ADU-K

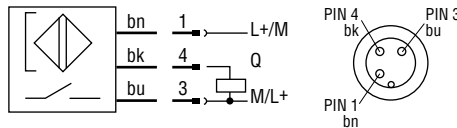

DIMENSIONS: SERIES JC1AD & JC1RD REED SWITCHES

JC1RDU-5

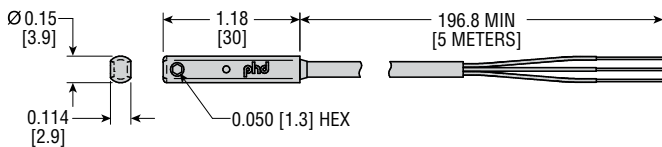

JC1RDU-K (Quick Connect)

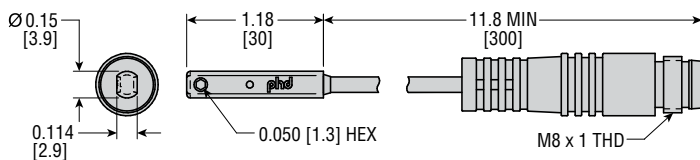

JC1ADU-K (Quick Connect)

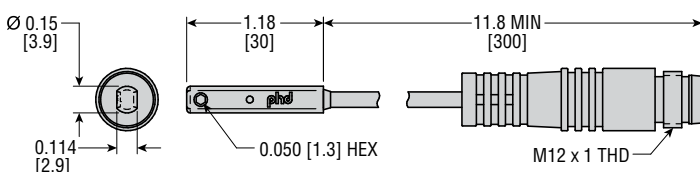

63549-xx CORDSET

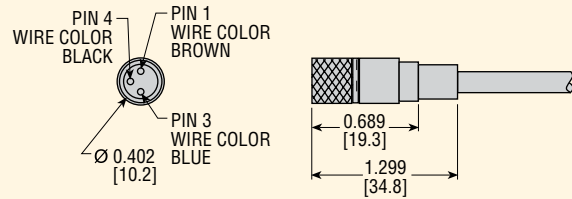

81284-1-010 CORDSET

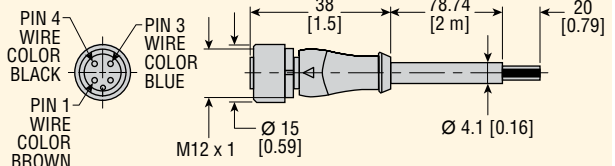

All dimensions are reference only unless specifically toleranced.

ENGINEERING DATA: SERIES JC1ST TEACHABLE SWITCHES

SERIES JC1ST TWO POSITION TEACHABLE MAGNETIC SWITCH

This switch provides the ability to identify two separately programmable positions with a single switch. Programmable capability means no “fine-tuning.” With switch properly aligned, just place actuator in desired positions and program. Solid-state sensing technology provides a highly reliable switch. Elliptical housing allows for easy “drop-in” installation from the side, and does not have to be inserted from the end of the slot. LED indicators on module for positioning and programming. Available with 2 meter cable or 8 mm threaded Quick Connect.

PART NO.	DESCRIPTION
JC1STP-2	PNP (Source) Solid State, 12-30 VDC, 2 meter cable
JC1STP-K	PNP (Source) Solid State, 12-30 VDC, Quick Connect

MATCHING CORDSET

PART NO.	DESCRIPTION
81284-1-001	M8, 4 pin, Straight Female Connector, 5 meter cable

SPECIFICATIONS	JC1STP-x
OPERATING PRINCIPLE	Programmable Magnetic Field Characterization
INPUT VOLTAGE	12-30 VDC
NUMBER & TYPE OF OUTPUTS	Two PNP (Source), separately adjustable
OUTPUT CURRENT	100 mA max., Short Circuit Protection
VOLTAGE DROP	≤ 2.2 VDC
SWITCH BURDEN	≤ 15 mA
ENVIRONMENTAL	IP67
OPERATING TEMPERATURE	-20° to 75°C
TYP. DETECTION AREA	0-50 mm

TEACHABLE WIRING SCHEMATICS

JC1STP-2 CABLED MODEL

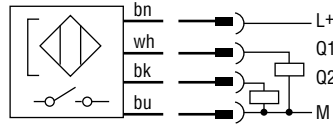

JC1STP-K QUICK CONNECT MODEL

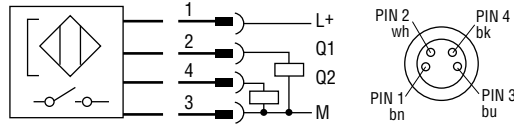

DIMENSIONS: SERIES JC1ST TEACHABLE SWITCHES

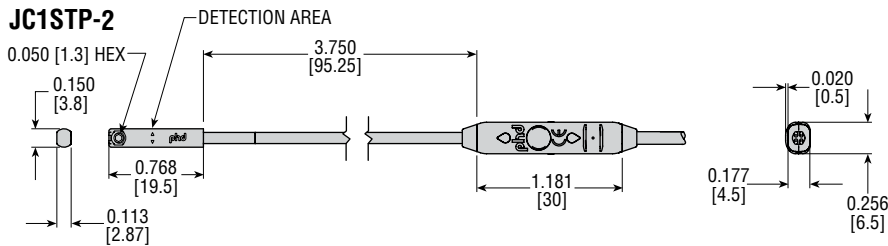

JC1STP-K (Quick Connect)

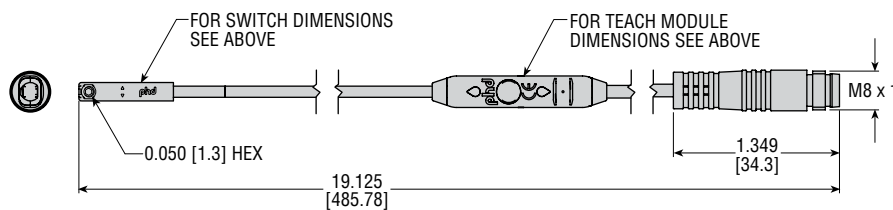

81284-1-001 CORDSET

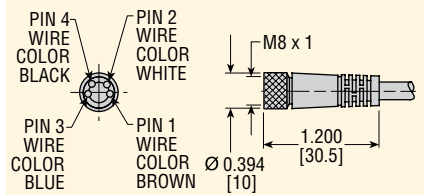

All dimensions are reference only unless specifically toleranced.

PROGRAMMING GUIDE: SERIES JC1 TEACHABLE SWITCHES

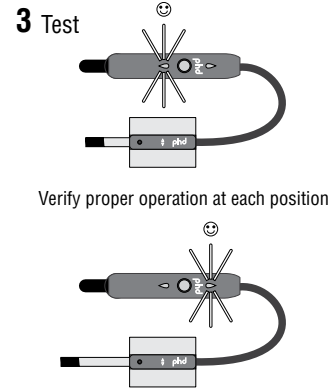
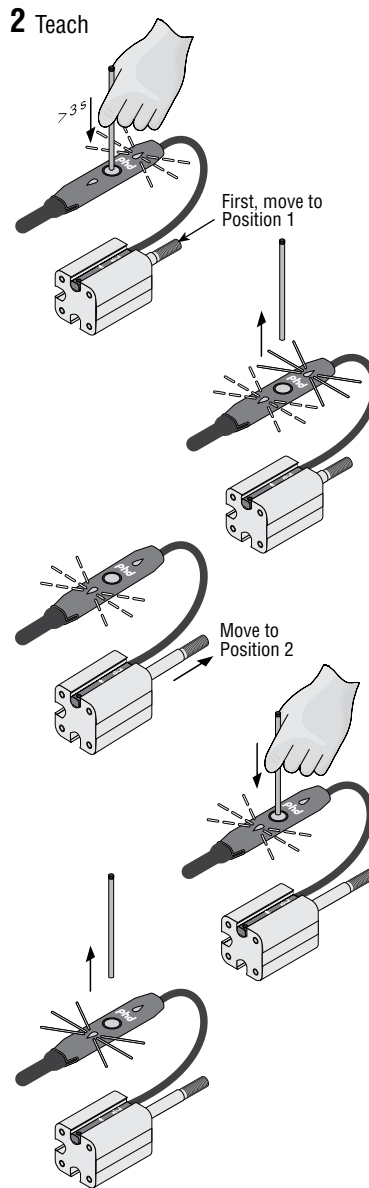
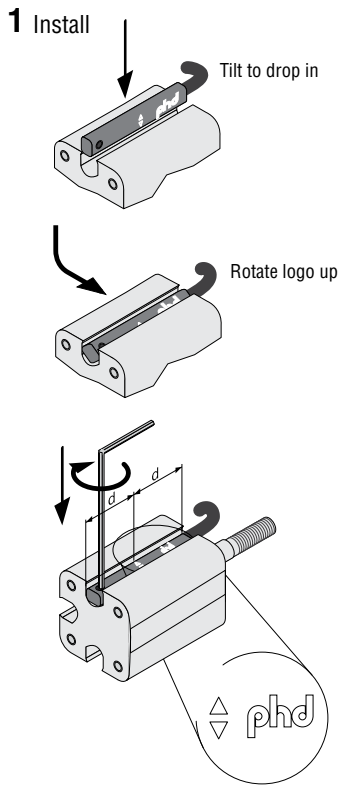

SETUP:

1 Insert sensor into the C-slot in the middle from above and tighten it using the hex key.

2 Connect the sensor to operating voltage (see specifications).

► Teach-in of the switching points:

Set the position for the 1st switching point

► Press the teach button for 3 seconds; LED 1 blinks

► Release teach button; 1st switching point is stored. LED 2 blinks (2nd switching point).

► Set the position for the 2nd switching point

► Press the teach button for a short time; 2nd switching point is stored.

3 Check the first and second switching points:

Move to the position for the first switching point. LED of the first switching point lights. If it does not light, check the application conditions and realign. Move to the position for the second switching point; LED of the first switching point turns off, and the LED of the second switching point lights. If the first LED does not turn off or the second LED does not light, check the application conditions and realign.

MAINTENANCE:

PHD magnetic cylinder sensors don't require maintenance. We recommend that you inspect the cable and plug in connections at regular intervals.